

WERK **BLOK** PYTHAGORAS

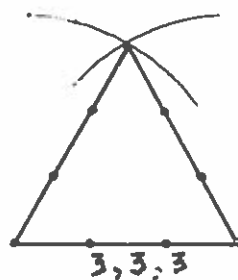

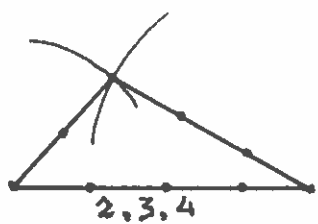

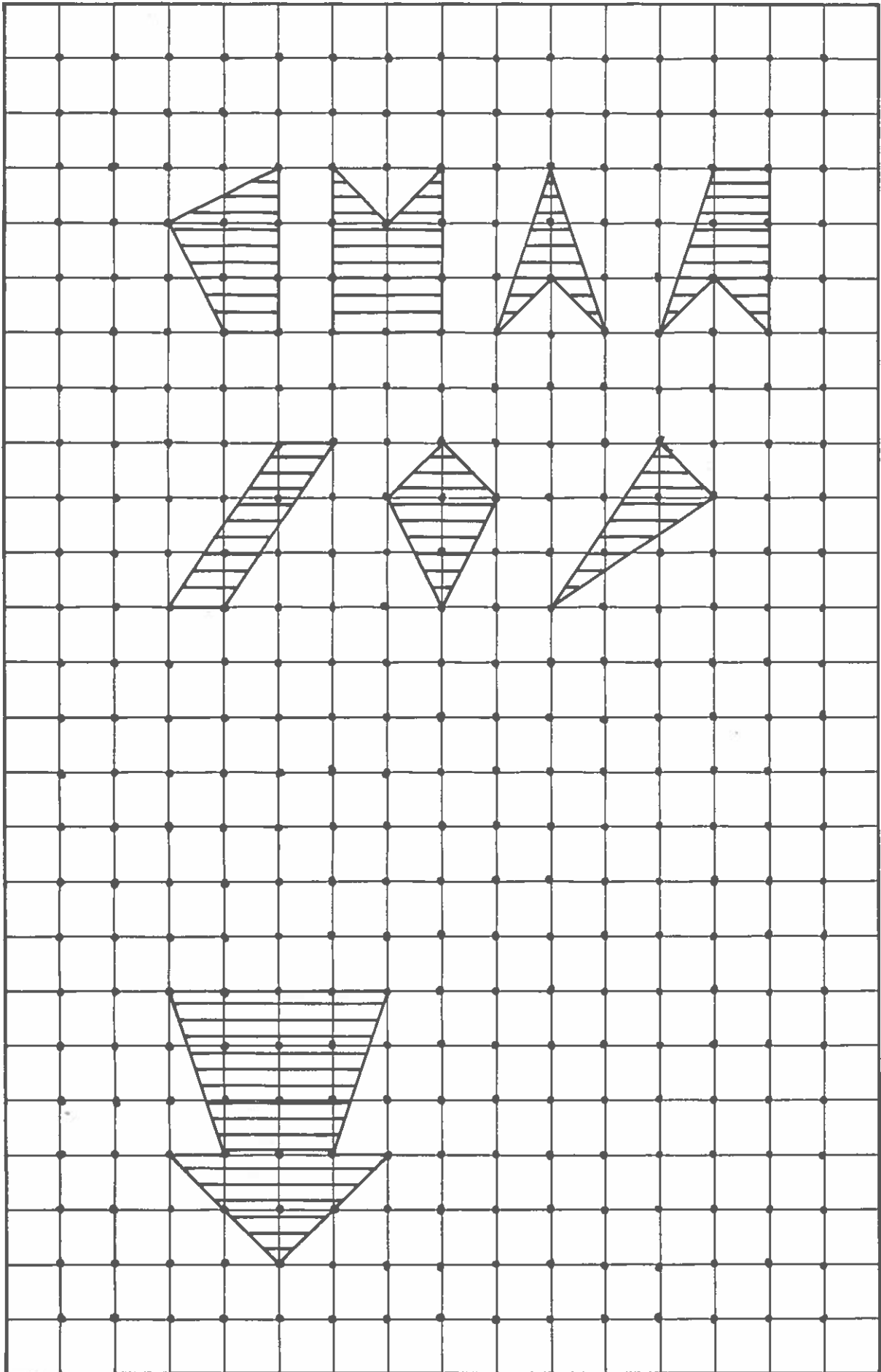
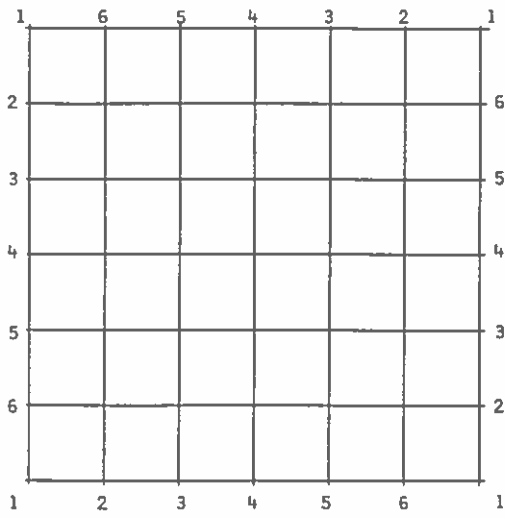

| vierkanten met<br>hoekpunten | oppervlakte<br>(spijkerhokjes) |
|------------------------------|--------------------------------|
| 1                            | ...                            |
| 2                            | ...                            |
| 3                            | ...                            |
| 4                            | ...                            |
| 5                            | ...                            |
| 6                            | ...                            |

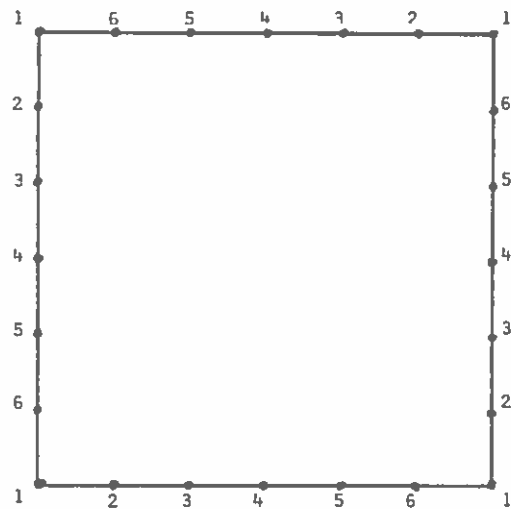
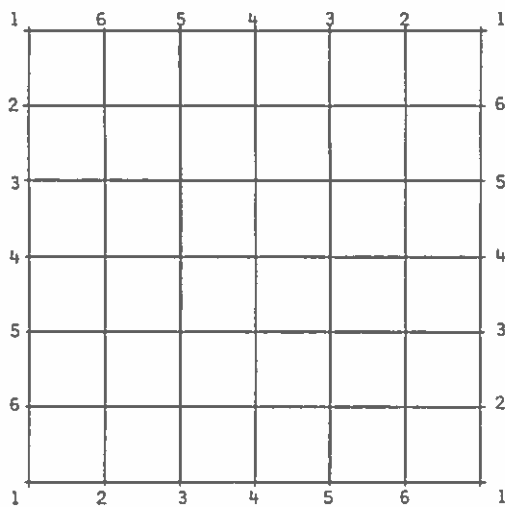
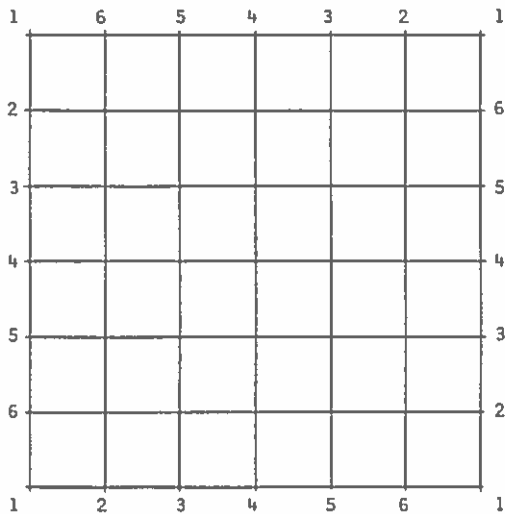

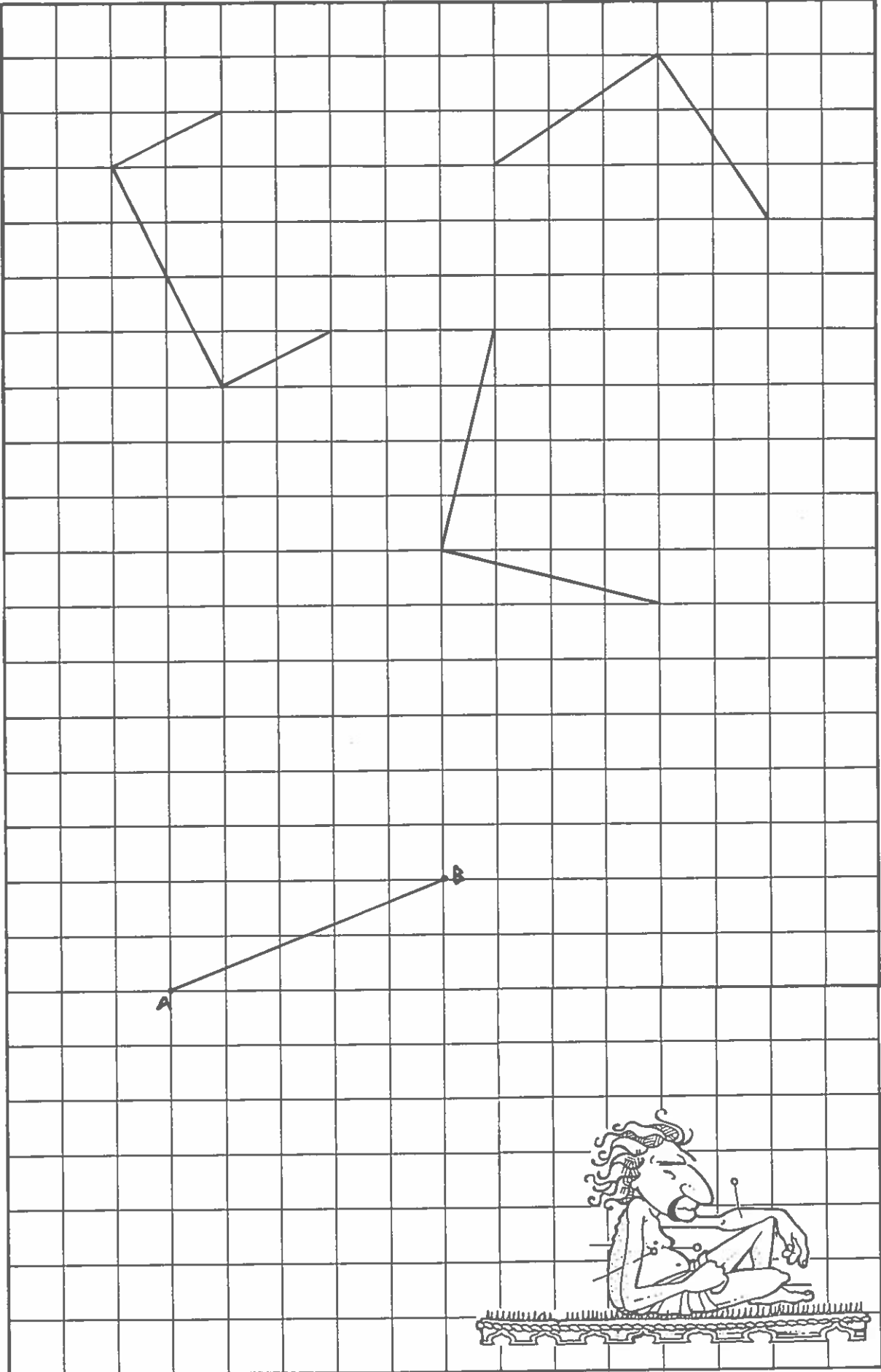

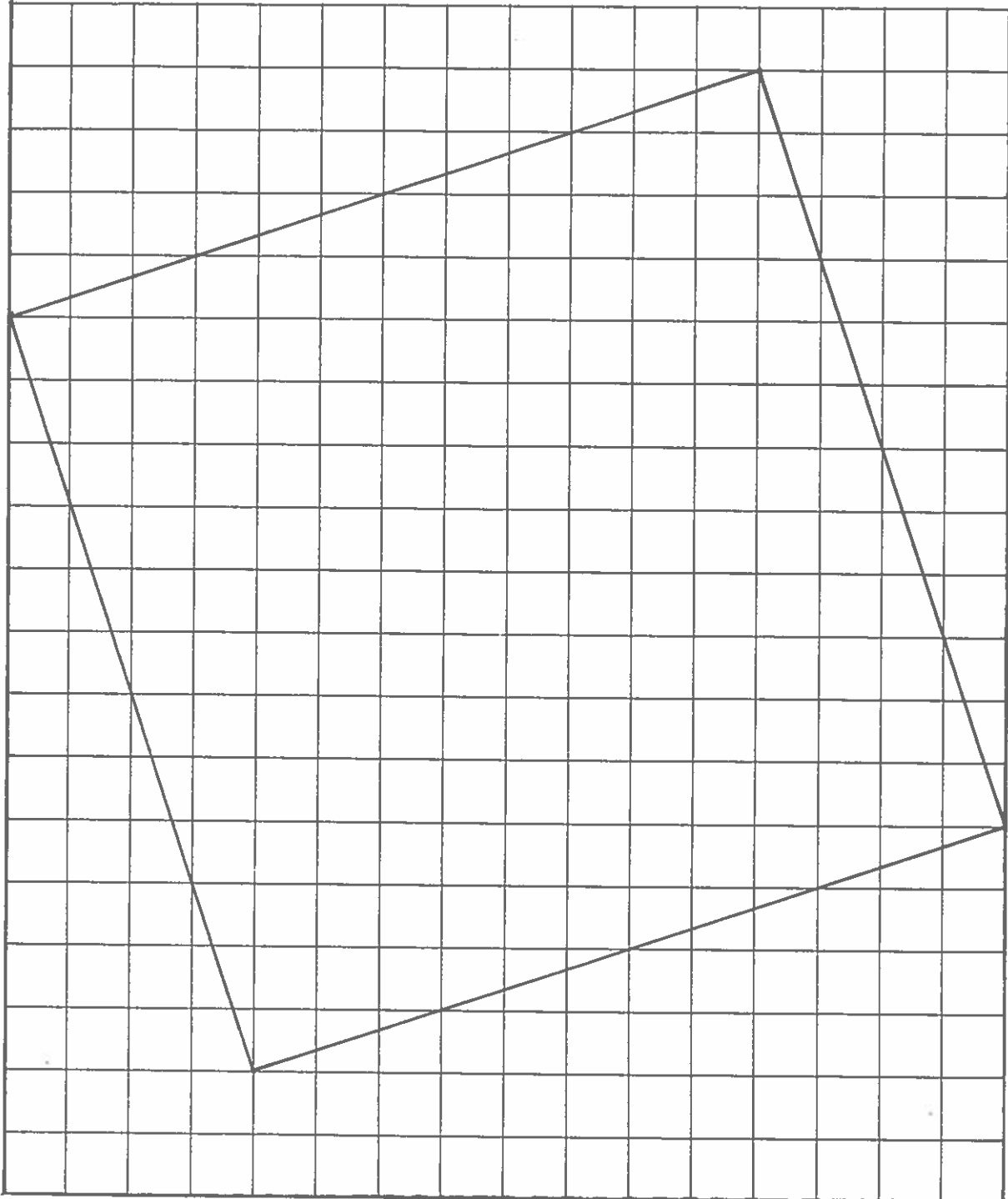
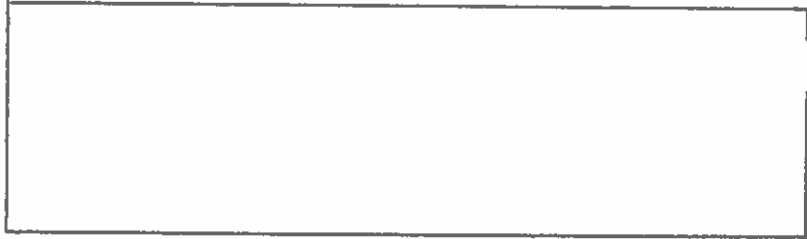

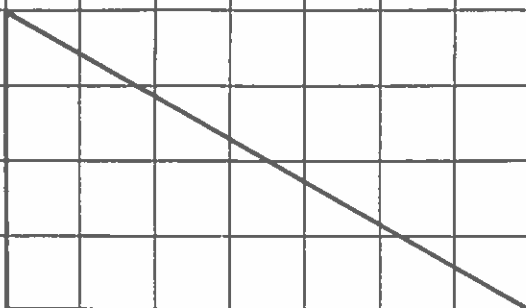

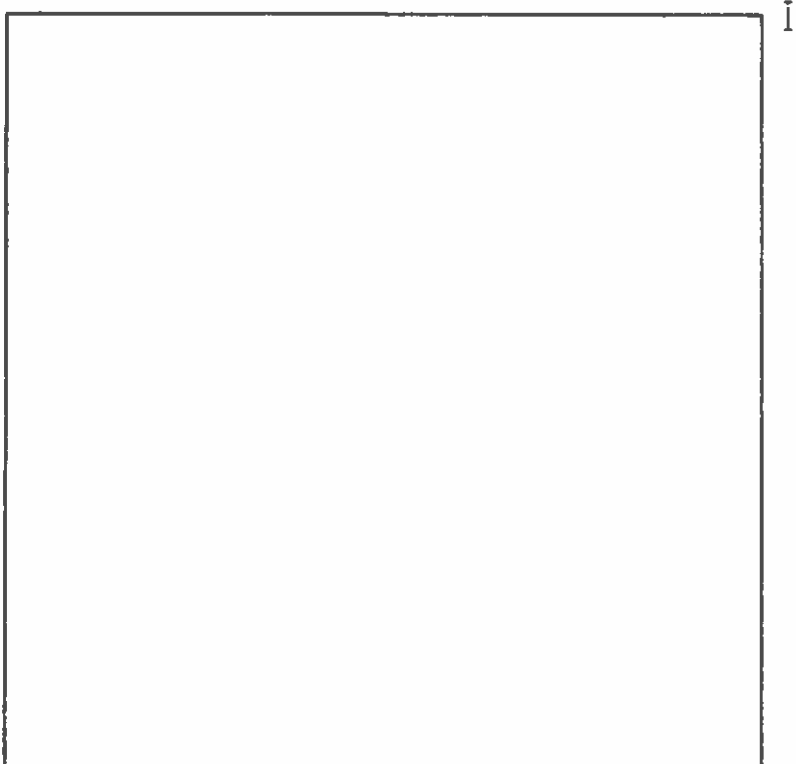
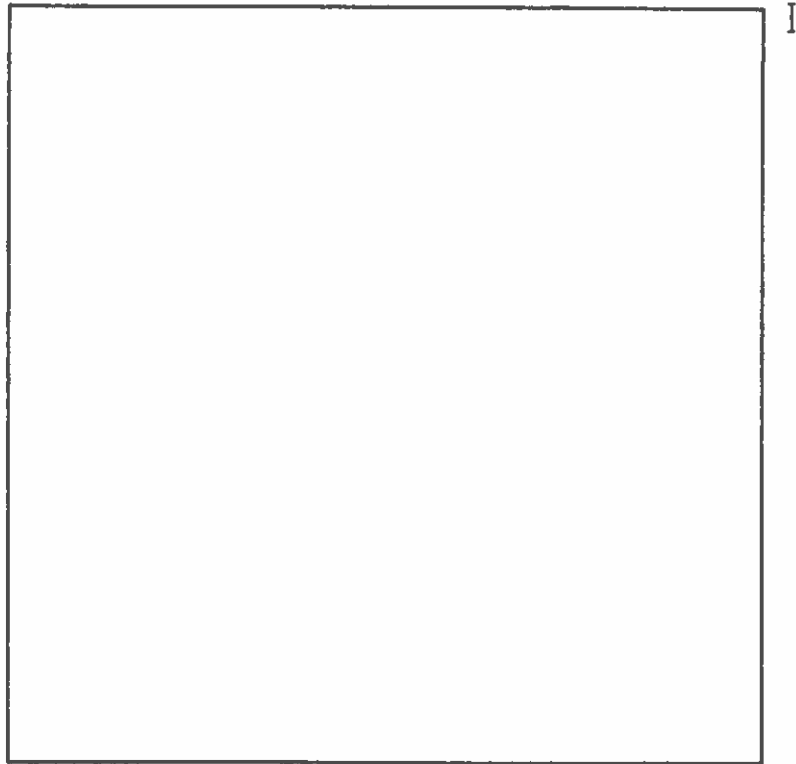



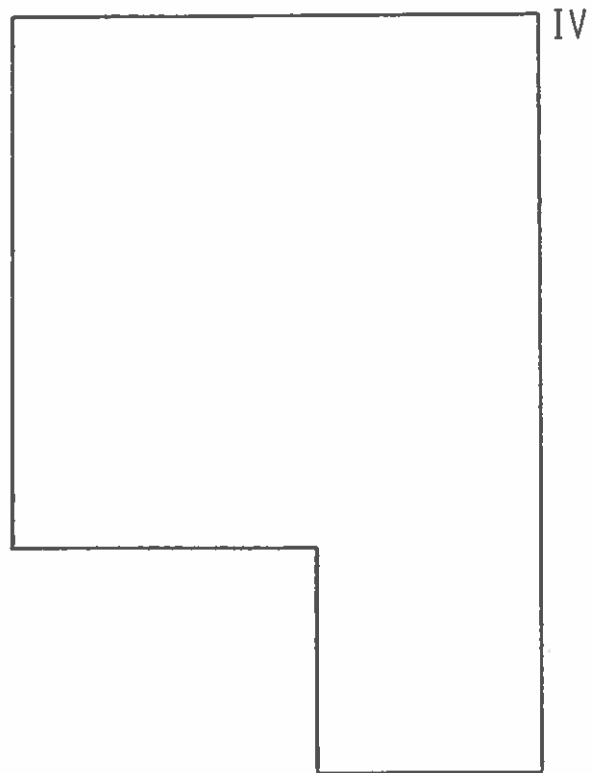
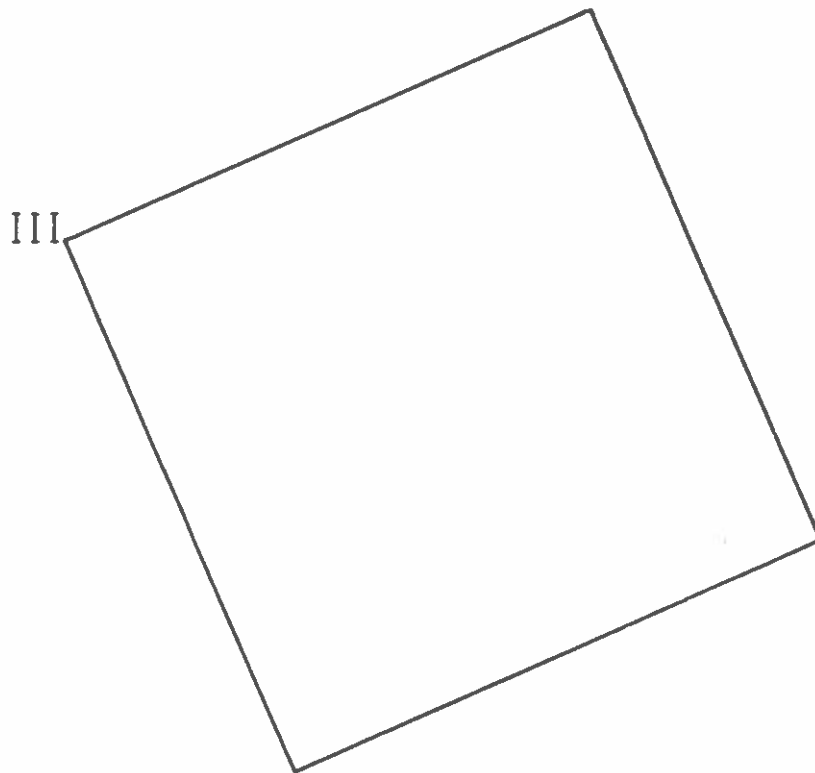

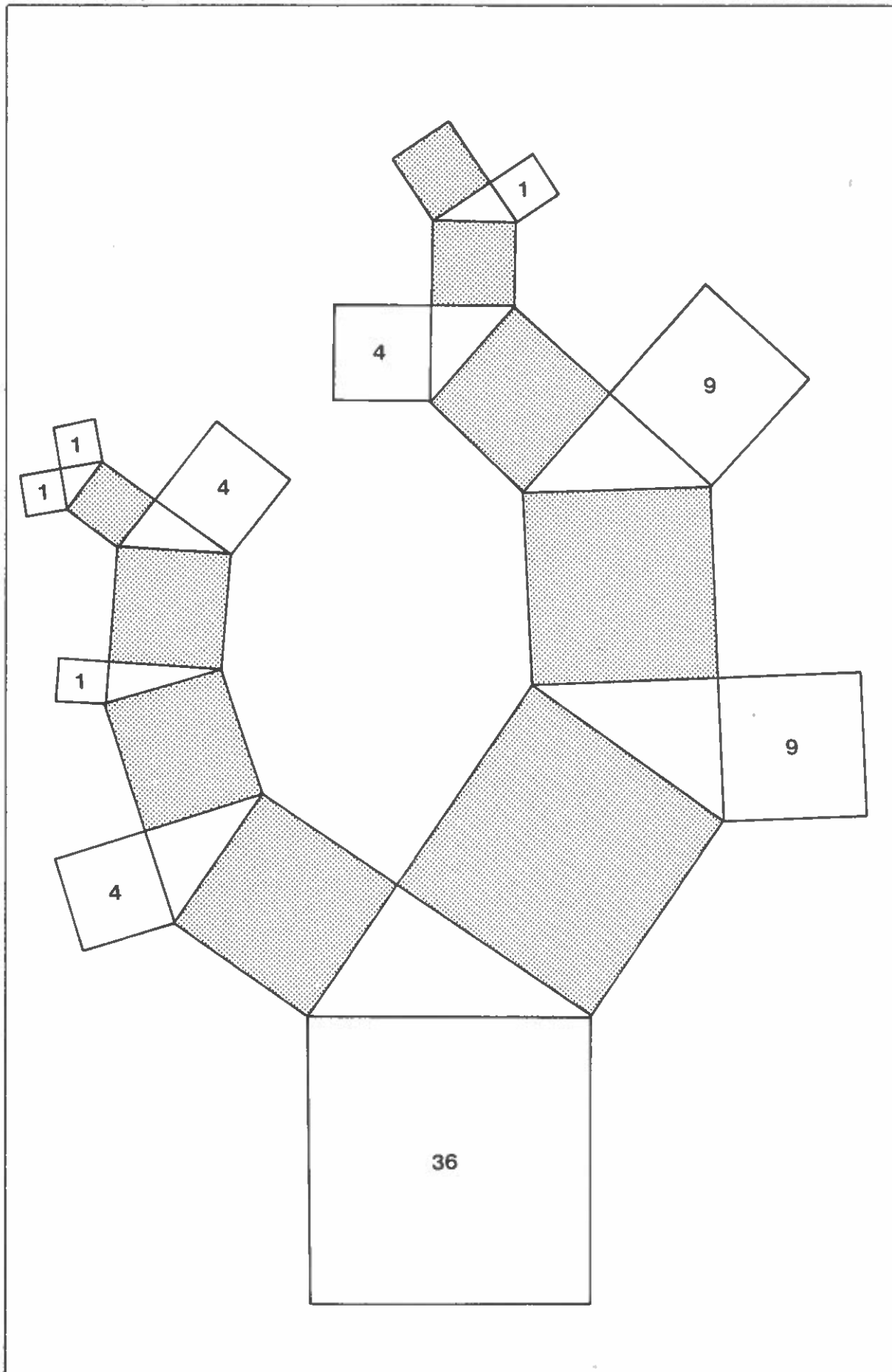

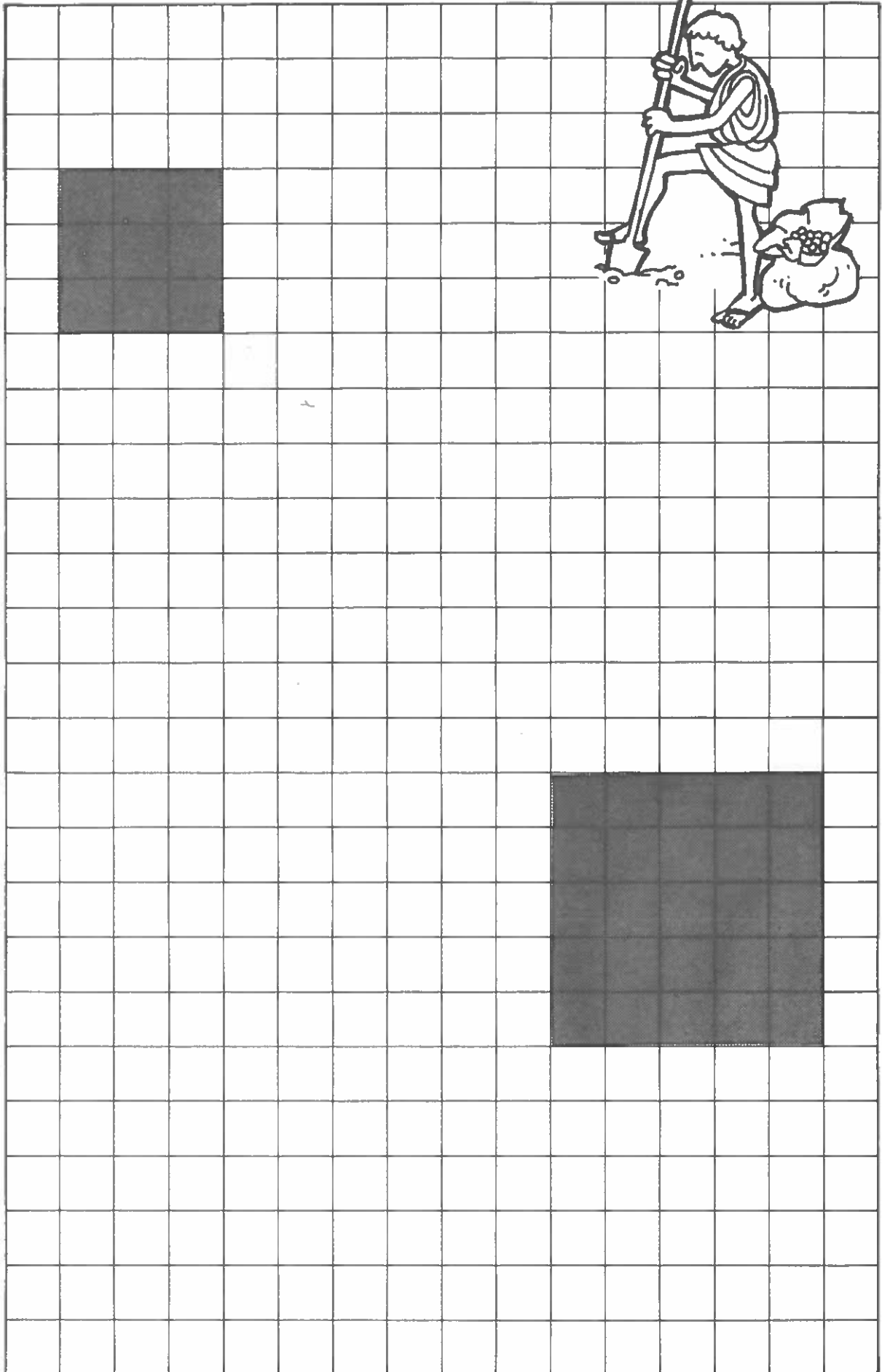

➤ Vul de hokjes in.

➤ Bereken de verschillen (bijv.  $10^2 - 9^2 = 19$ ) en schrijf die uitkomsten naast de tussenstreepjes. Wat zie je aan die getallen?

|        |     |
|--------|-----|
| $1^2$  |     |
| $2^2$  |     |
| $3^2$  |     |
| $4^2$  |     |
| $5^2$  |     |
| $6^2$  |     |
| $7^2$  |     |
| $8^2$  |     |
| $9^2$  | 81  |
| $10^2$ | 100 |
| $11^2$ |     |
| $12^2$ |     |
| $13^2$ |     |
| $14^2$ |     |
| $15^2$ |     |
| $16^2$ |     |
| $17^2$ |     |
| $18^2$ |     |
| $19^2$ |     |
| $20^2$ |     |

➤ 19

De tegelzetter van de farao had een mooie stapel vierkanten gemaakt.

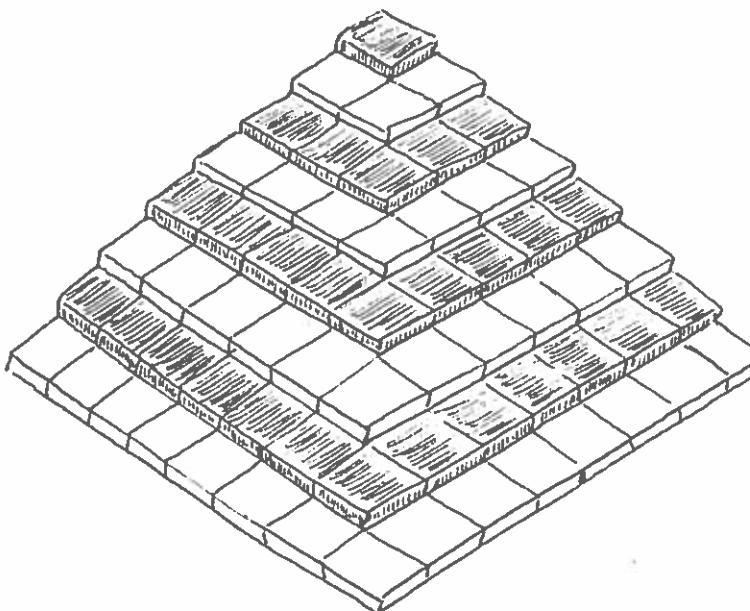

➤ Hoeveel tegels liggen er in die stapel?

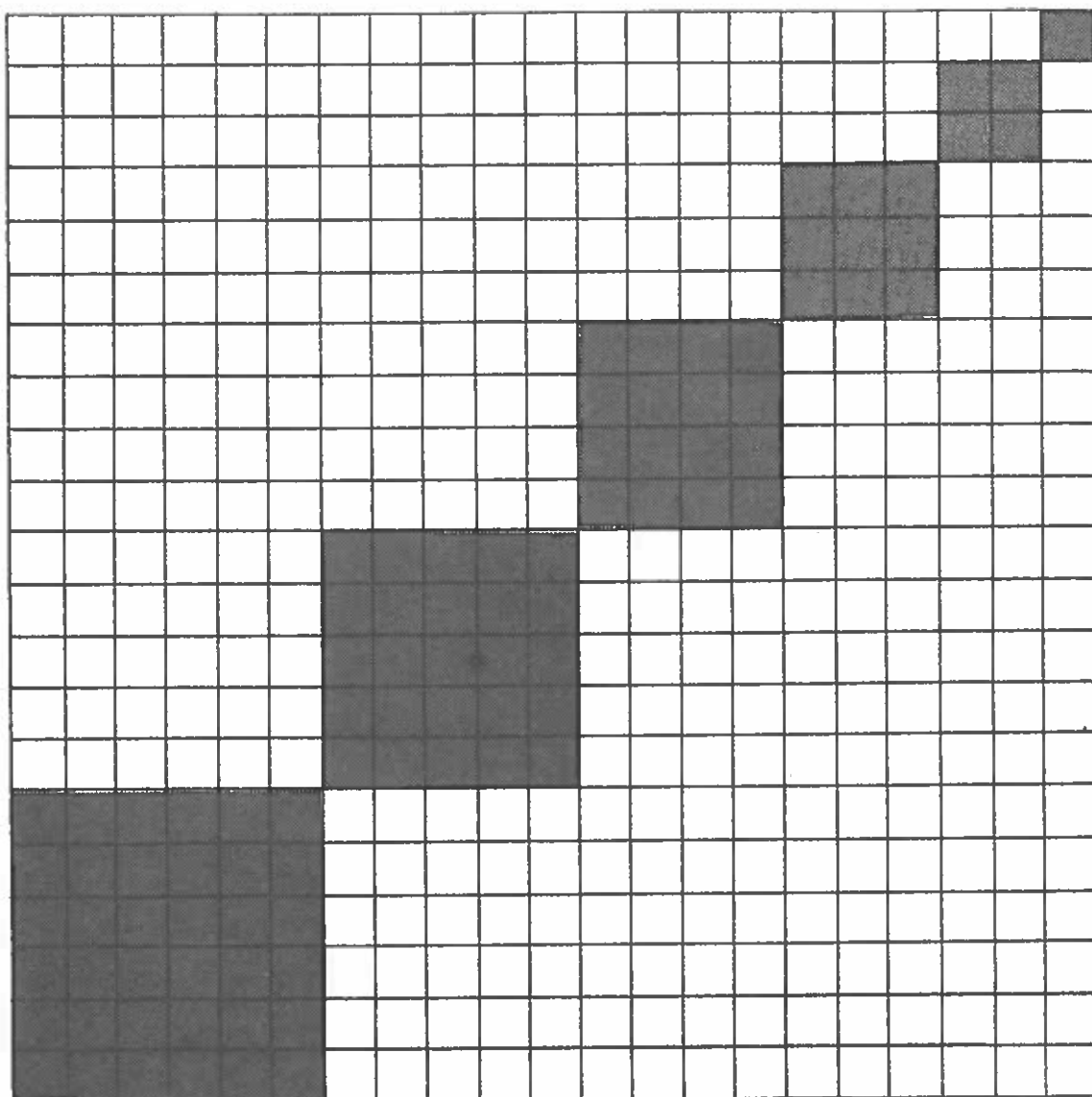

➤ Hoeveel grijze tegels liggen er op deze tegelvloer?

Berekening

➤ En hoeveel witte tegels?

Berekening

Een stukje Brabants bont.

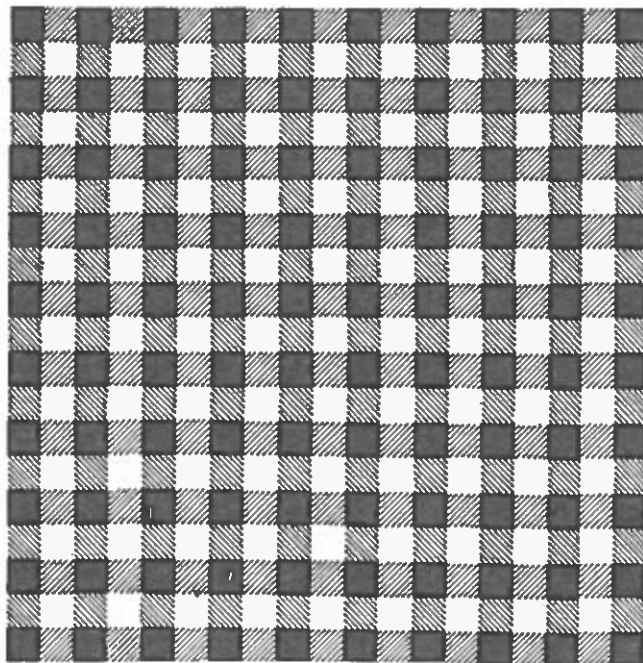

» Hoeveel zwarte blokjes zitten er in?

Hoeveel witte?

En hoeveel grijze?

Berekening

» Als alle zwarte blokjes uit dit kleedje geknipt worden, kun je daar precies een vierkant mee leggen?

Kan dat ook met de witte blokjes?

En met de grijze blokjes?

Leg eens uit waarom.

➤ Hoeveel driehoekjes?

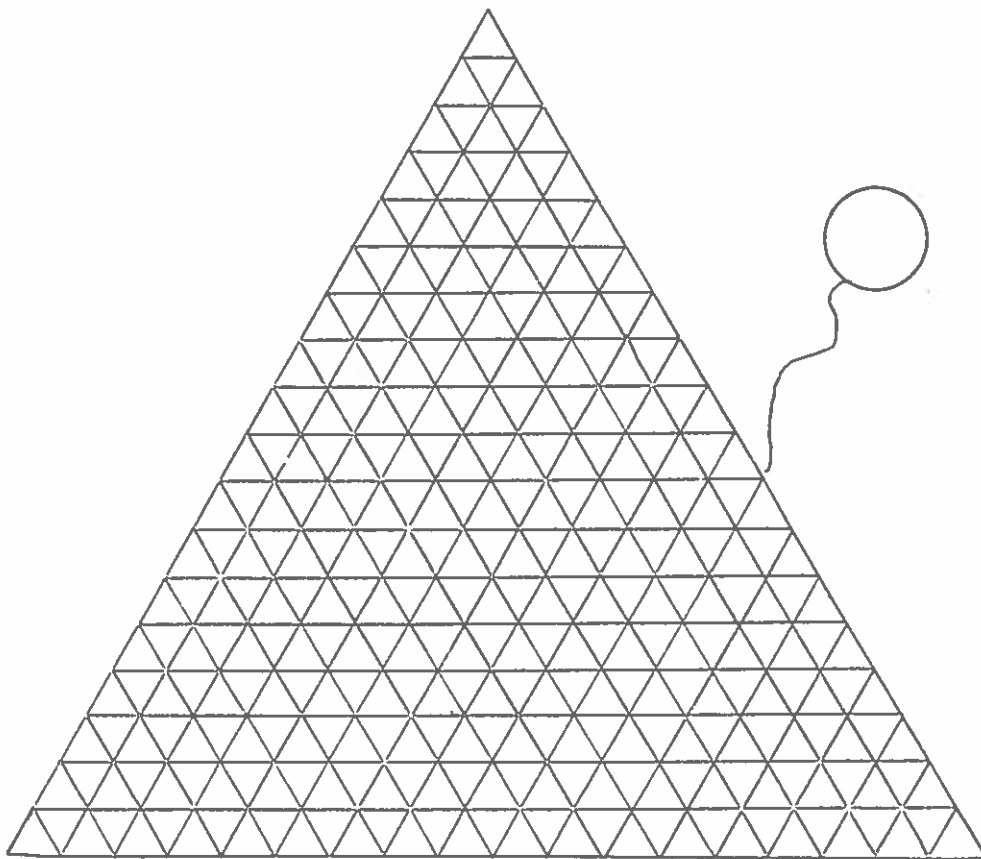
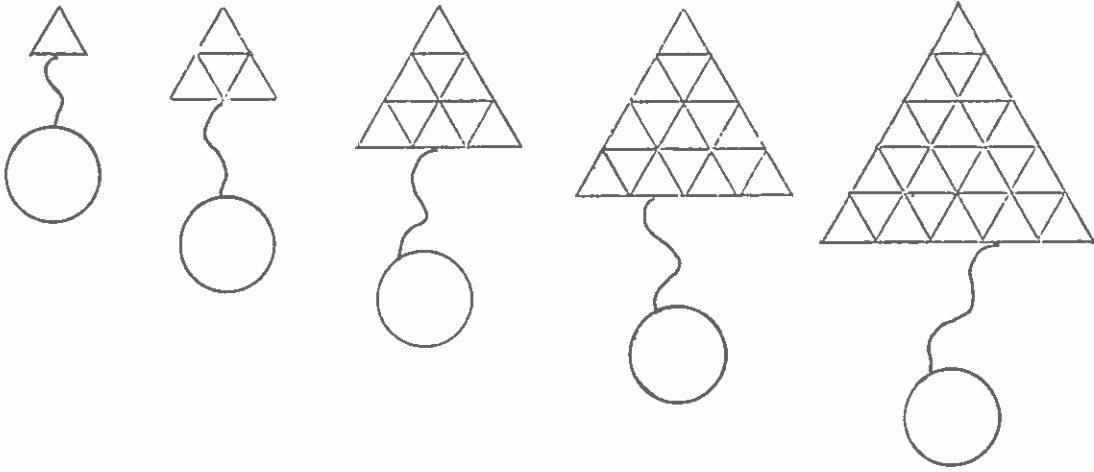

➤ Hoeveel vierkantjes?

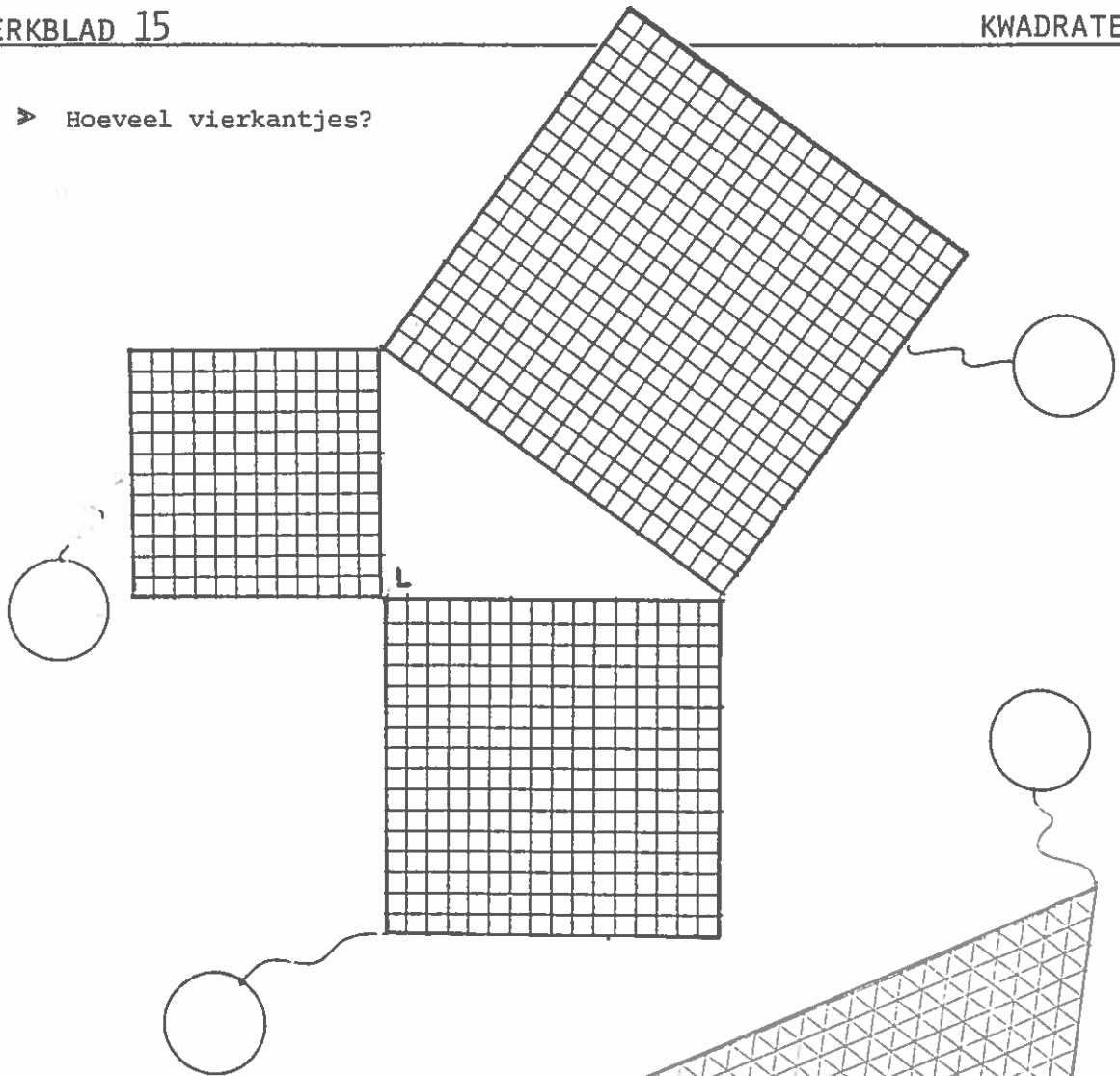

➤ Hoeveel driehoekjes?

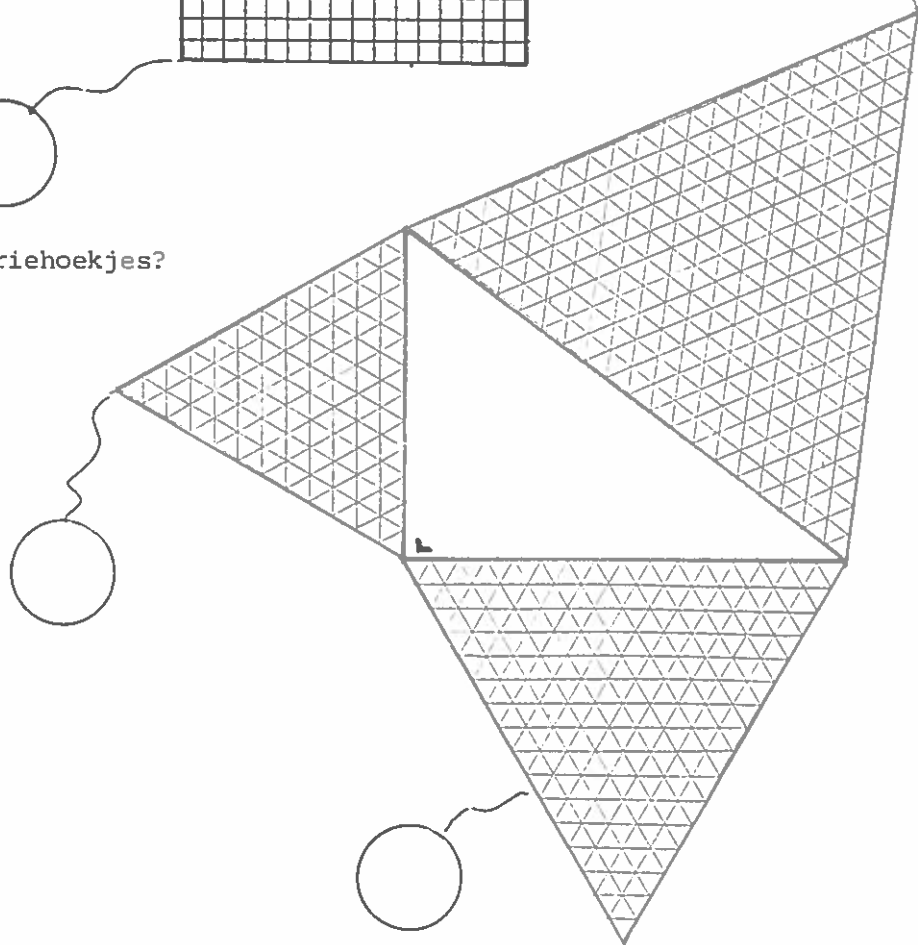





$11^2 = \dots$

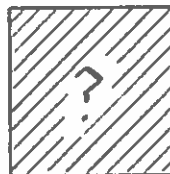
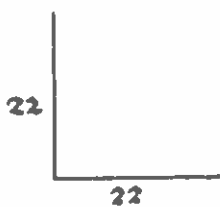

$22^2 = \dots$

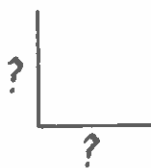

$\sqrt{225} = \dots$

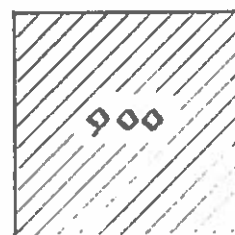
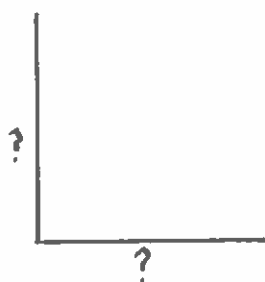

$\sqrt{900} = \dots$

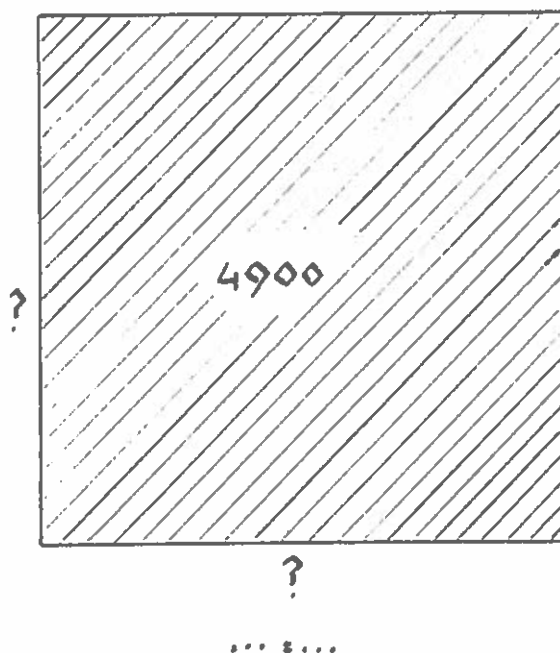
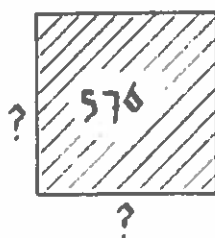
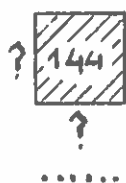

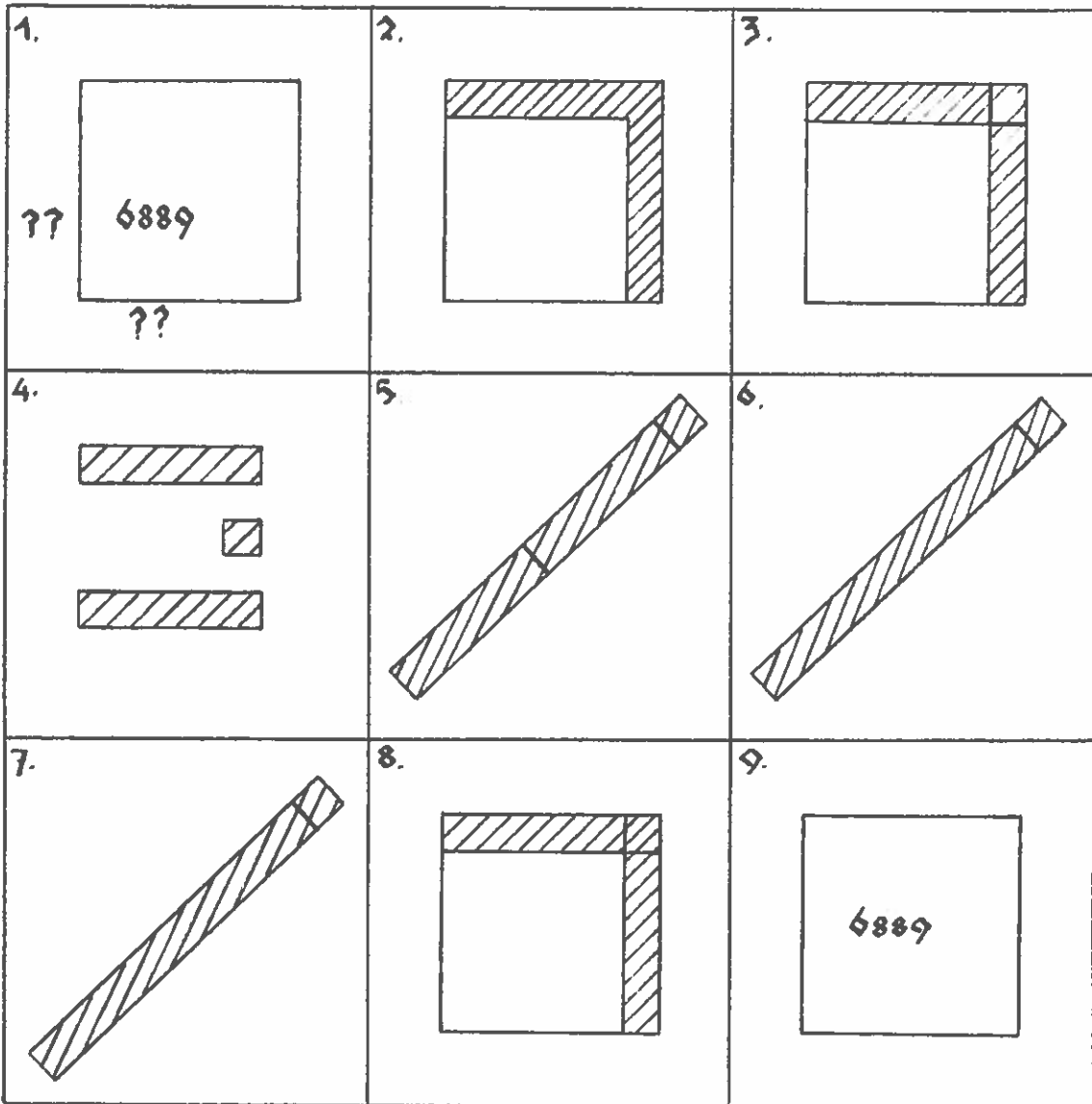

Dus :  $\sqrt{6889} = \dots\dots$

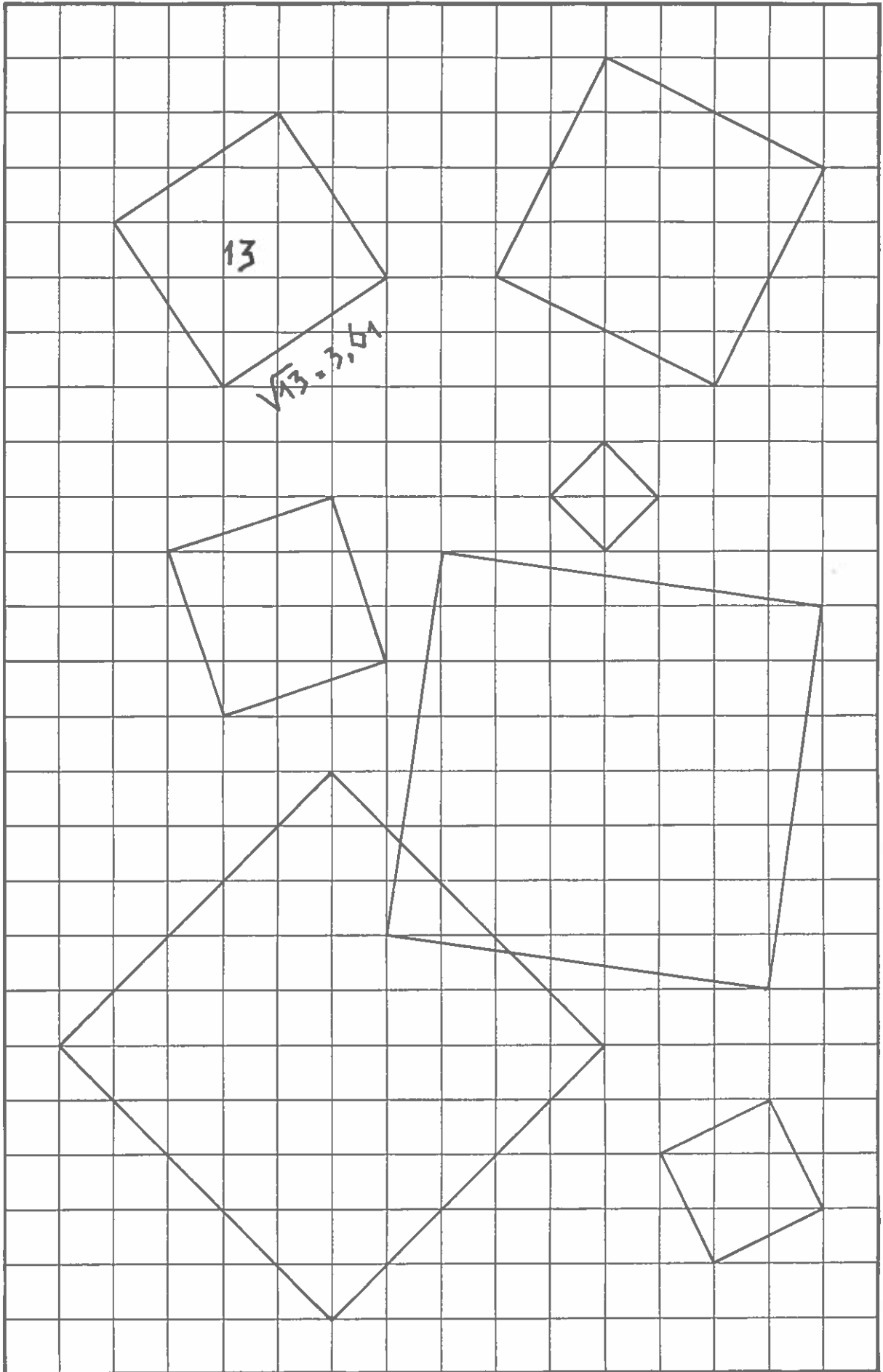

| zijde (cm) | opp. (cm <sup>2</sup> ) |
|------------|-------------------------|
| 1          | 1                       |
| 2          | 4                       |
| 3          | -                       |
| 4          | -                       |
| 5          | -                       |
| 6          | -                       |
| 7          | -                       |
| 8          | -                       |
| 9          | -                       |
| 10         | -                       |

| zijde (cm) | opp. (cm <sup>2</sup> ) |
|------------|-------------------------|
| 0,5        | 0,25                    |
| 1,5        | 2,25                    |
| 2,5        | -                       |
| 3,5        | -                       |
| 4,5        | -                       |
| 5,5        | -                       |
| 6,5        | -                       |
| 7,5        | -                       |
| 8,5        | -                       |
| 9,5        | -                       |

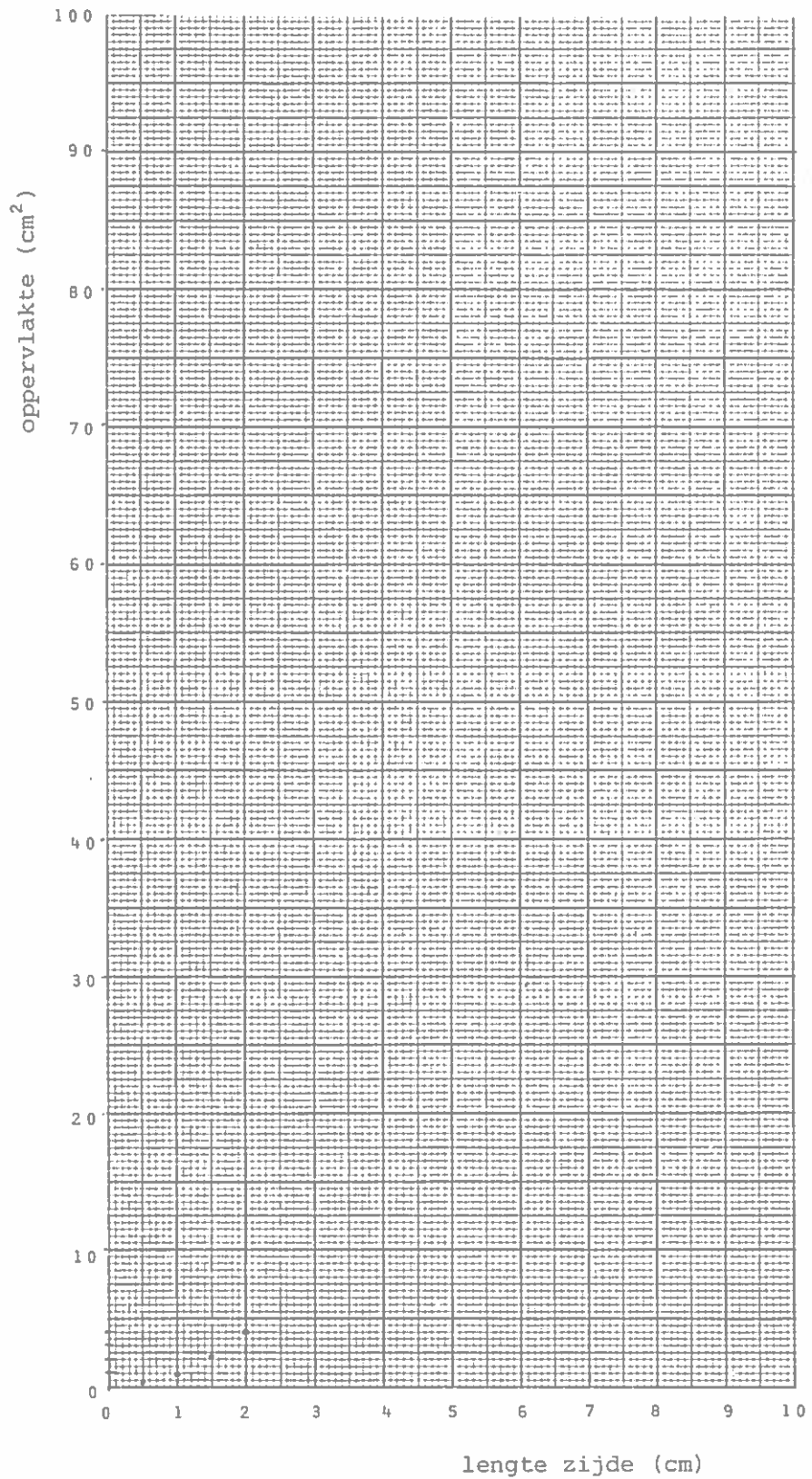

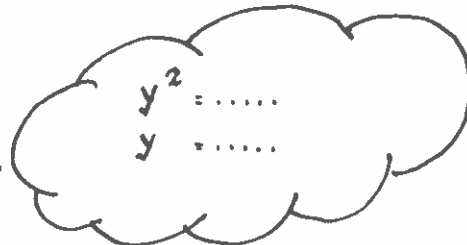
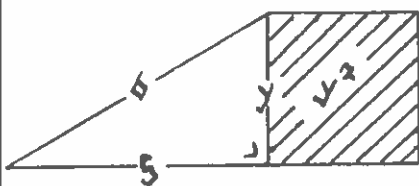
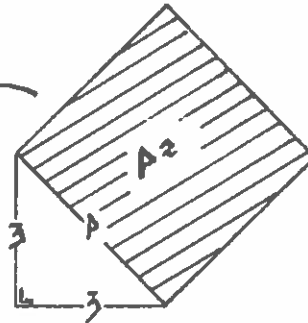
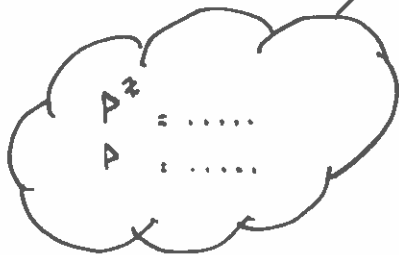
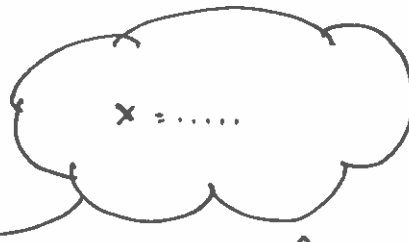
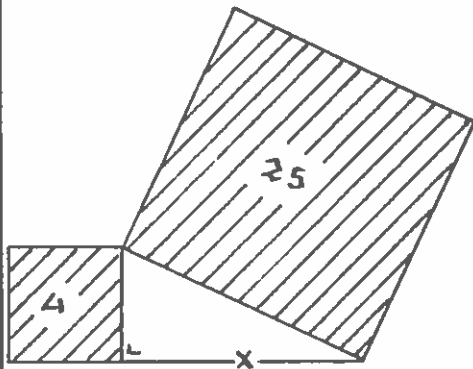
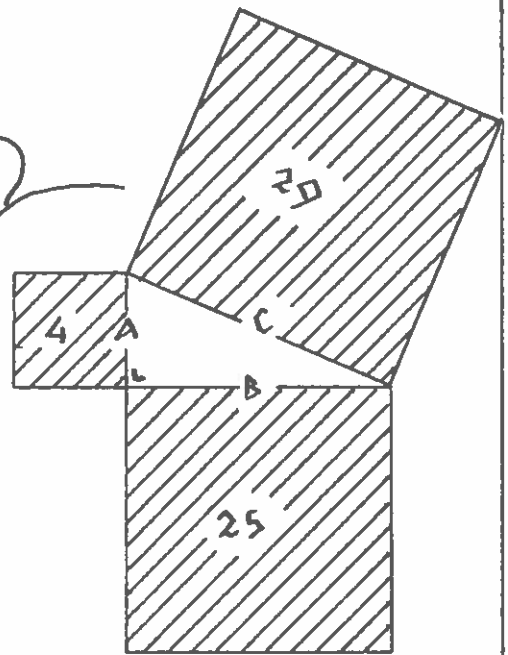
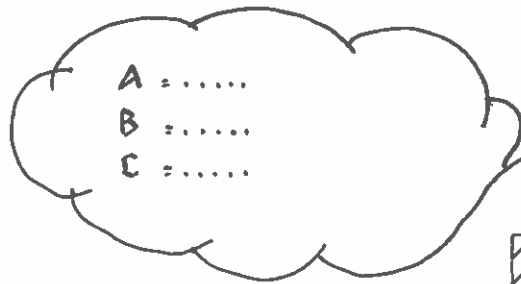



o o o o

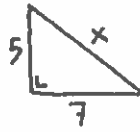

$$\begin{aligned}x^2 &= 5^2 + 7^2 \\x^2 &= 25 + 49 \\x^2 &= 74 \\x &= \sqrt{74} \approx 8,60\end{aligned}$$

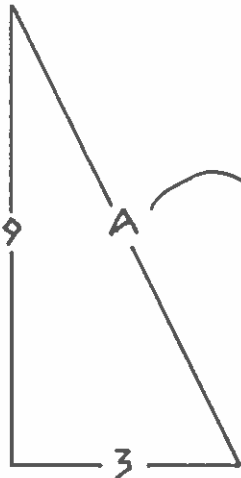

\_\_\_\_\_

\_\_\_\_\_

\_\_\_\_\_

\_\_\_\_\_

\_\_\_\_\_

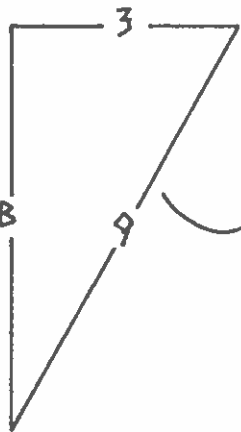

\_\_\_\_\_

\_\_\_\_\_

\_\_\_\_\_

\_\_\_\_\_

\_\_\_\_\_

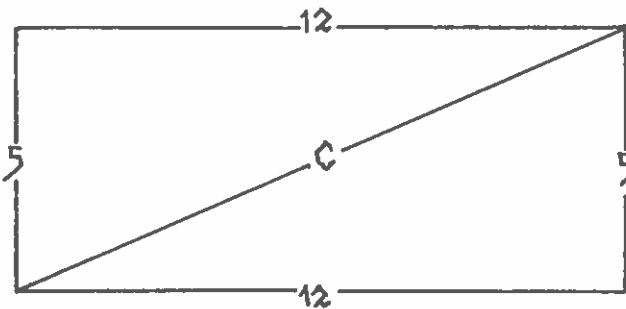

\_\_\_\_\_

\_\_\_\_\_

\_\_\_\_\_

\_\_\_\_\_

\_\_\_\_\_

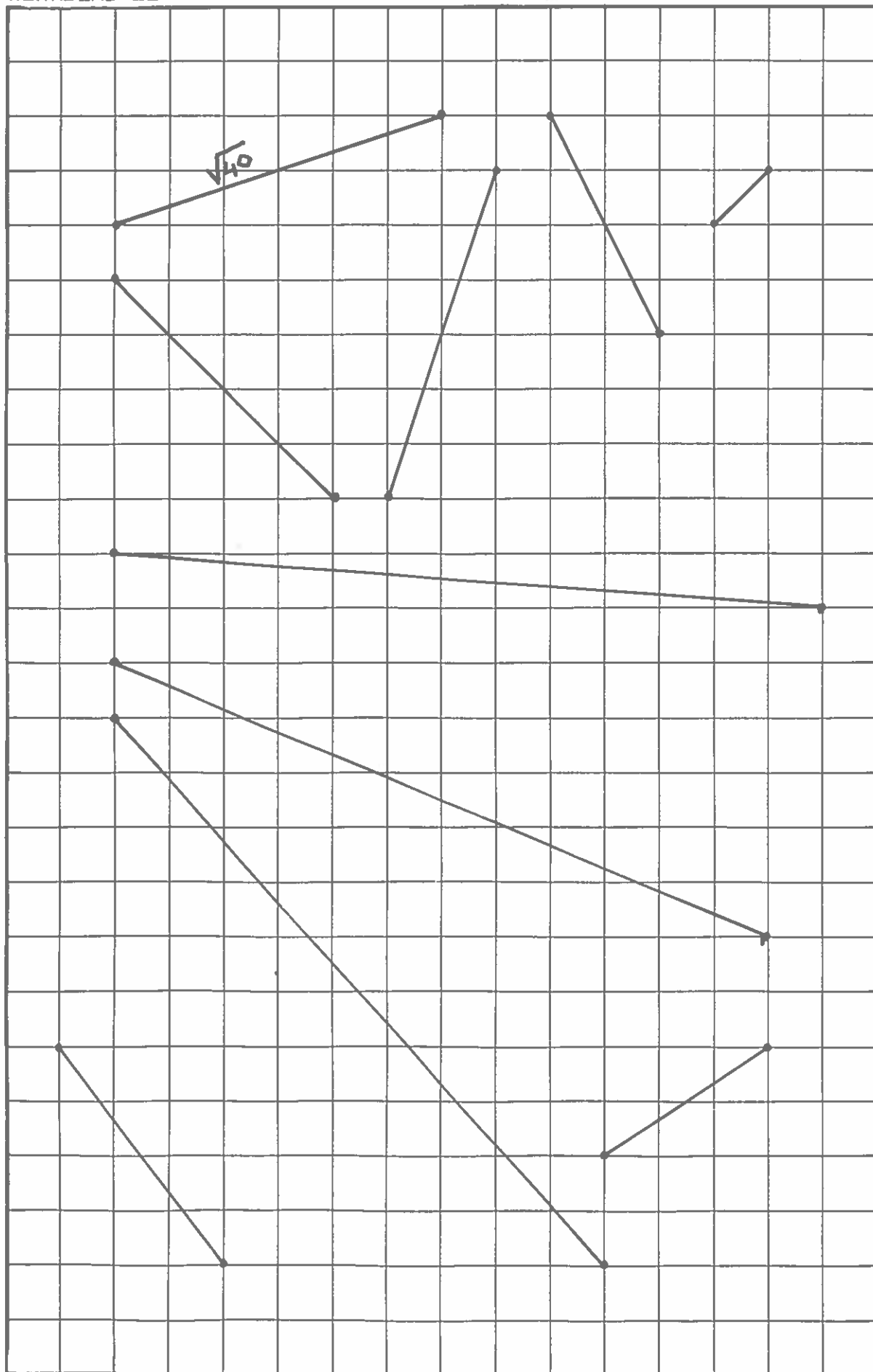

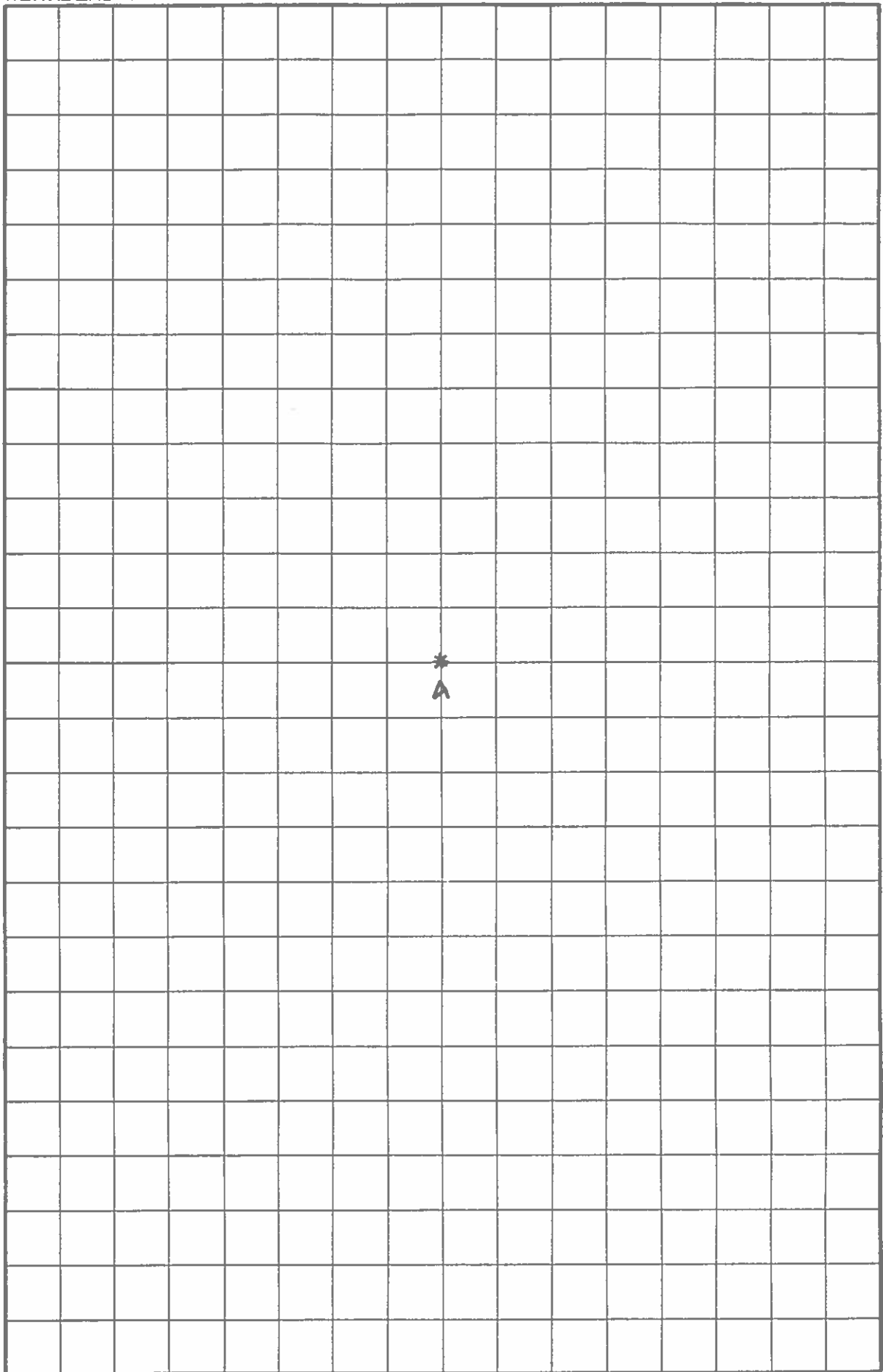

\*  
A



AFSTAND TUSSEN  
BISMARCK ← N  
SUFFOLK < KM >

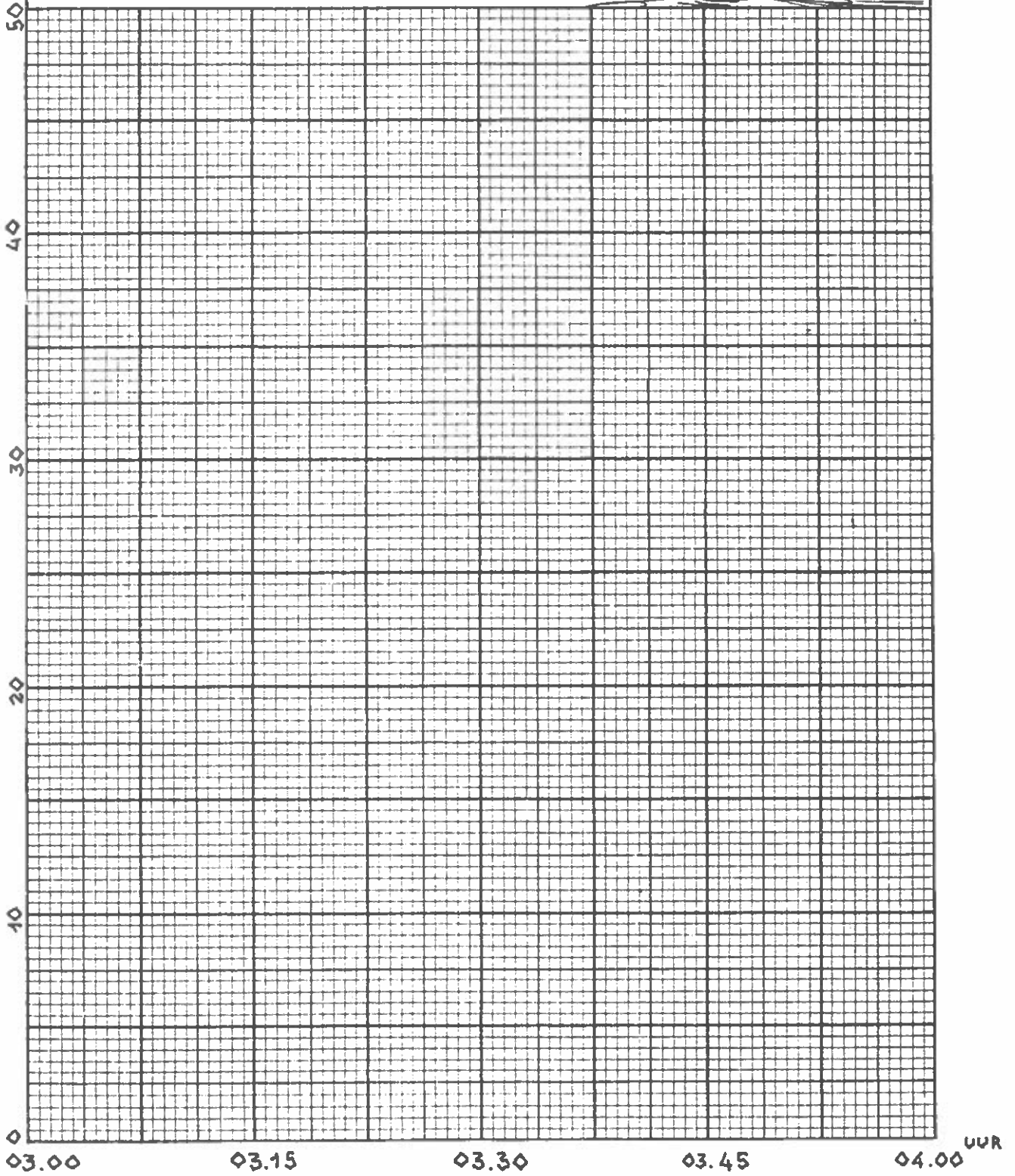
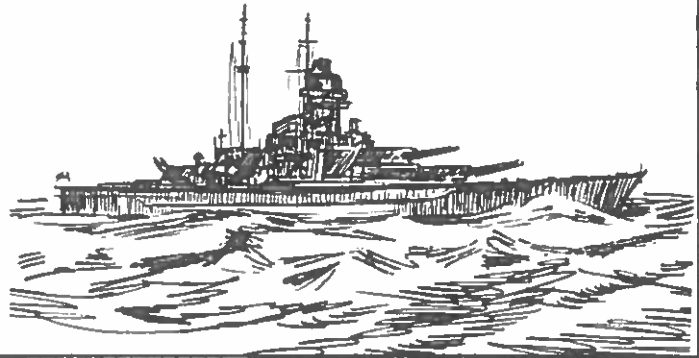

KAART 1

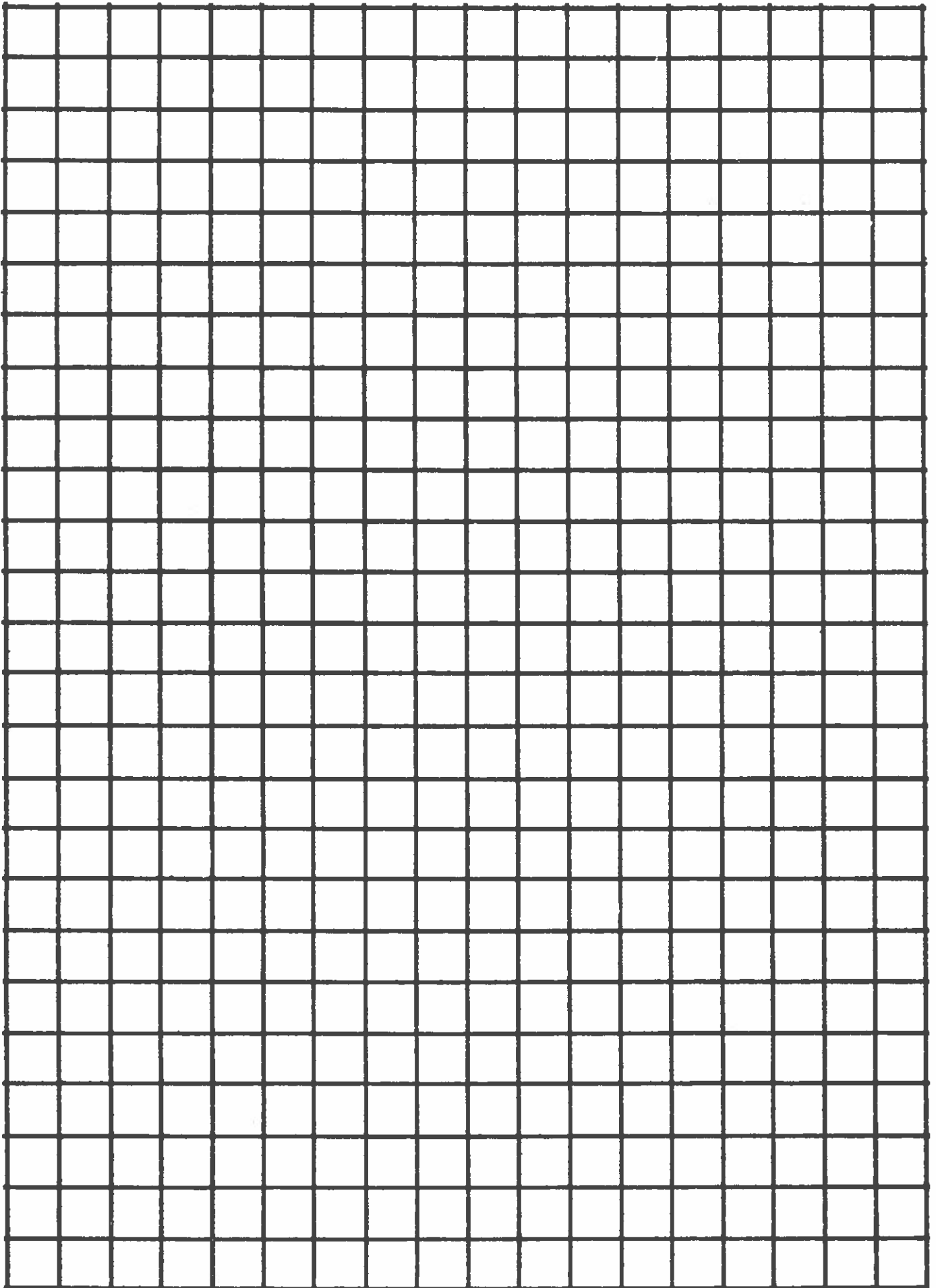

KAART 5

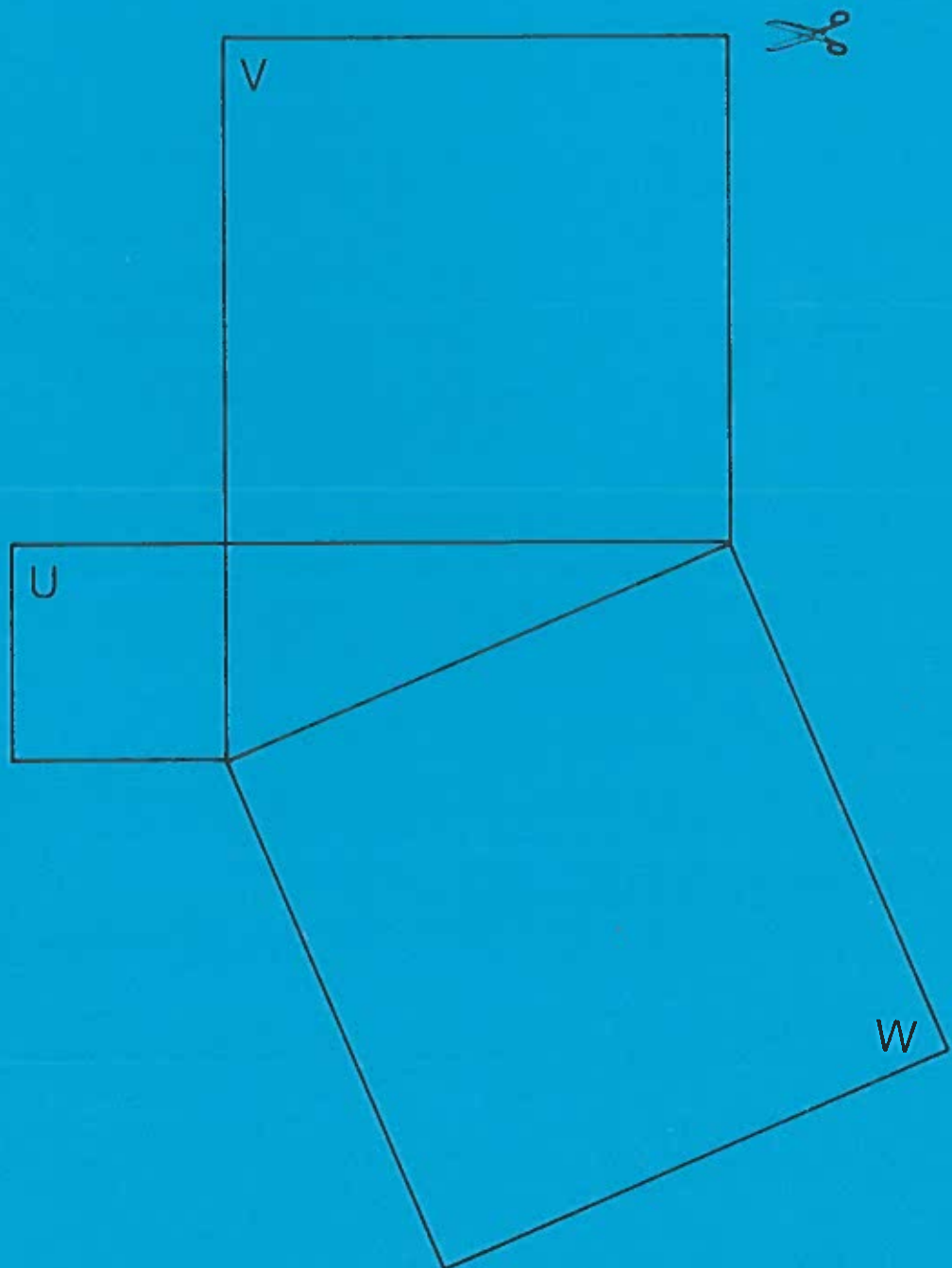

KAART 6

